

The logo for Gaviota Simbac features a white, stylized arch above the brand name. The arch is composed of two curved lines that meet at the top, resembling a bird's wing or a simple bridge. The text 'Gaviota Simbac' is written in a clean, white, sans-serif font, positioned directly below the arch. The entire logo is set against a vibrant red background that has a subtle, wavy pattern of lighter red and orange tones, giving it a sense of movement and depth.

Gaviota Simbac

Punto Recto / Curved Arms / Store à Bras Courbé / Bracci Curvi





Indico 

Brazos de punto recto. Tres opciones de brazos: sin tensión / semi-tensión / con tensión.
Especialmente diseñado para ventanas sin balcón, aunque puede ser aplicado en otras estructuras igualmente.
Posibilidad de montaje con cofre NauticoN1 Premium y cofre DesertD1.

Curved Arms System. Three options for the arms: without tension / medium-tension / with tension.
Although it might be especially designed for windows without balcony, it can be used in many other cases.
Assembly option with Premium NauticoN1 box and DesertD1 box.

Bras courbés. Trois positions de bras: sans tension / semi-tension / avec tension.
Spécialement conçu pour fenêtres sans balcon, mais également applicable sur d'autres structures.
Possibilité de montage avec coffre NauticoN1 Premium et coffre DesertD1.

Braccia a caduta. Tre opzioni di braccia: senza tensione / con semi-tensione / con tensione.
Progettate specificatamente per finestre e vetrine di negozi.
Possibilità montaggio con cassonetto Nautico N1 Premium e cassonetto Desert D1.

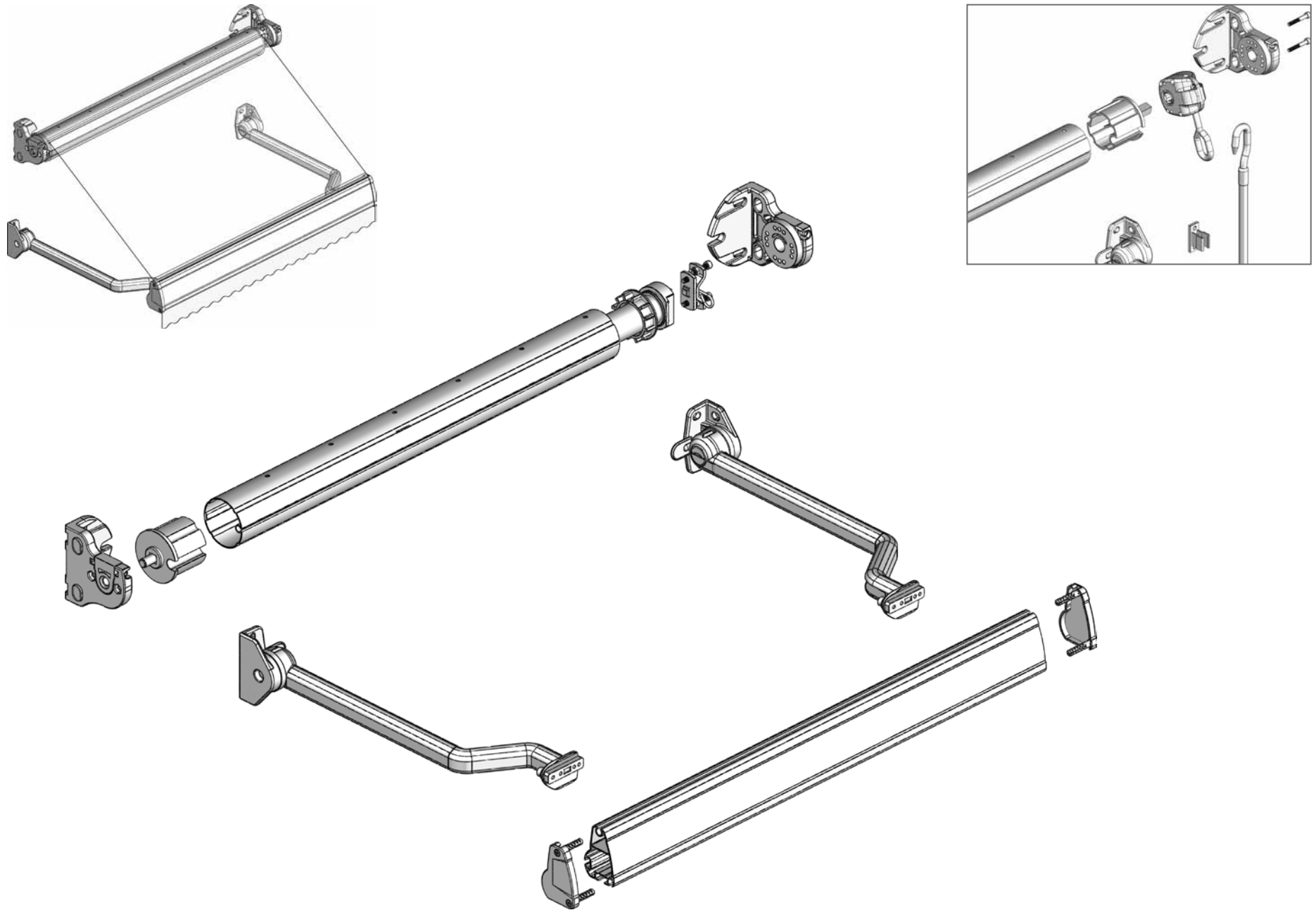

Despiece sistema / System parts / Système détaché / Esploso del sistema

Ejemplo para montaje IndicoI2, 3,50 m x 1,20 m (Línea x Salida). Color blanco
Assembly example for IndicoI2 with 3,50 m width and 1,20 m arms projection. White colour
Exemple de montage IndicoI2, 3,50 m x 1,20 m (Largeur x Avancée). Couleur blanc
Esempio di montaggio Sistema Indico I2, 3,50 m x 1,20 m braccio. Nel colore bianco

Ejemplo IndicoI2 motorizado / Example for IndicoI2 with motor / Exemple IndicoI2 avec moteur / Esempio Sistema Indico I2 manovra a motore

Descripción / Description Description / Descrizione	Código / Code Code / Codice	Cantidad / Quantity Quantité / Quantità
Tubo ranurado galvanizado / Galvanized round tube with ogive / Tube rond à gorge galvanisé / Rullo con ogiva	8003-23	4 m
Casquillo 70 mm ranurado de aluminio para punto, espiga redonda 12x20 mm / Round cap of 70 mm with round pivot of 12x20 mm in aluminum <i>Embout mâle côté opposé, sortie ronde 12x20 mm, en aluminium / Calotta con ogiva Ø 70 mm alluminio con perno Ø 12x20 mm</i>	8002-38	1
Juego anclaje inyeccion caset sin espiga / Set of injection brackets without round pivot <i>Jeu de supports injection sans téton type cassette / Set supporti in pressofusione senza perno</i>	8004-176	1
Juego brazo curvo I2, con semi-tensión (1,20 m) / Set of curved arms I2, with semi-tension (1,20 m) <i>Jeu bras courbé I2, avec ressort de semi-tension (1,20 m) / Kit bracci curvi I2 con molla semi-tensione (1,20 m)</i>	8006-380	1
Perfil Bambu 2 / Bambu2 profile / Profil Bambu2 / Profilo terminale Bambu 2	8005-304	4 m
Juego de tapas perfil Bambu2 / Set of caps for Bambu2 profile / Jeu d'embouts pour profil Bambu2 / Kit tappi profilo terminale Bambu 2	8005-312	1
Motor Logos 10 / Logos 10 Motor / Moteur Logos 10 / Motore Logos 10	6005-96	1
Acople para eje de 70 mm con ogiva / Adapter for 70 mm tube with ogive / Accouplement pour axe de 70 mm ogiva / Adattatore per rullo ogiva Ø 70 mm	6007-14	1
Emisor 1 canal Cronos / Cronos 1 remote control / Emetteur 1 canal Cronos / Telecomando a 1 canale Cronos	6009-118	1
Soporte obra y toldo serie 50 / 50 series bracket (built-in and awnings) / Support traditionnel et store serie 50 / Supporto motore con perno quadro 10 mm	6008-3	1

Ejemplo IndicoI2 con máquina / Example for IndicoI2 with gear / Exemple IndicoI2 avec treuil / Esempio Sistema Indico I2 manovra ad argano

Descripción / Description Description / Descrizione	Código / Code Code / Codice	Cantidad / Quantity Quantité / Quantità
Máquina Ciclon 1/7 cáncamo 90 mm acero zincado, roscada / <i>Cyclon gear 1/7 90 mm eye, zinc steel, rolled</i> <i>Treuil Cyclon 1/7 anneau 90 mm acier zingué, vissé / Arganello Ciclon 1/7 occhiolo L90 mm, fori filettati</i>	8001-185	1
Tubo ranurado galvanizado / <i>Galvanized round tube with ogive</i> / <i>Tube rond à gorge galvanisé / Rullo con ogiva</i>	8003-23	4 m
Casquillo 70 mm ranurado de aluminio para máquina, espiga cuadrada 13x33 mm / <i>Driving round cap of 70 mm with square pivot of 13x33 mm in aluminum</i> <i>Embout mâle côté manoeuvre, sortie carrée 13x33 mm, en aluminium / Calotta con ogiva Ø 70 mm alluminio con perno quadro 13x33 mm</i>	8002-28	1
Casquillo 70 mm ranurado de aluminio para punto, espiga redonda 12x20 mm / <i>Round cap of 70 mm with round pivot of 12x20 mm in aluminum</i> <i>Embout mâle côté opposé, sortie ronde 12x20 mm, en aluminium / Calotta con ogiva Ø 70 mm alluminio con perno Ø 12x20 mm</i>	8002-38	1
Juego anclaje inyeccion caset sin espiga / <i>Set of injection brackets without round pivot</i> <i>Jeu de supports injection sans téton type cassette / Set supporti in pressofusione senza perno</i>	8004-176	1
Juego brazo curvo I2, con semi-tensión (1,20 m) / <i>Set of curved arms I2, with semi-tension (1,20 m)</i> <i>Jeu bras courbé I2, avec ressort de semi-tension (1,20 m) / Kit bracci curvi I2 con molla semi-tensione (1,20 m)</i>	8006-380	1
Perfil Bambu 2 / <i>Bambu2 profile / Profil Bambu2 / Profilo terminale Bambu 2</i>	8005-304	4 m
Juego de tapas perfil Bambu2 / <i>Set of caps for Bambu2 profile / Jeu d'embouts pour profil Bambu2 / Kit tappi profilo Bambu2</i>	8005-312	1
Manivela extra lacada gancho zincado (1,20 m) / <i>Lacquered handcrank, zinc plated steel hook (1,20 m)</i> <i>Manivelle laquée crochet zingué (1,20 m) / Asta verniciata gancio zinc (1,20 m)</i>	8009-9	1
Pinza sujeta manivela de poliamida / <i>Polyamide handle lock / Bloqueur de manivelle en polyamide / Ferma asta plastica</i>	7010-39	1

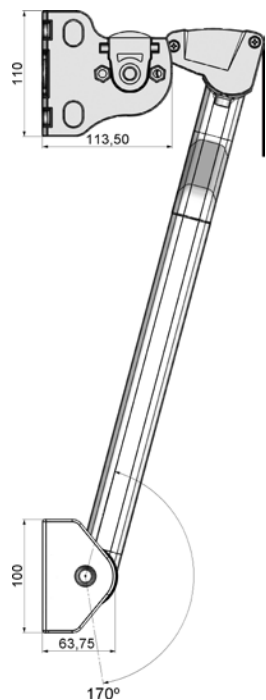

Inclinación máxima

Maximum inclination

Inclinaison maximale

Inclinazione massima

El sistema Indico tiene tres modelos:

Sistema I1: Brazo sin tensión.

Sistema I2: Brazo de semitensión (la tensión está en el soporte).

Sistema I3: Brazo de tensión (la tensión está en el brazo mediante un muelle interno).

There are three options for the arms in the Indico System:

I1 System: The arm has no tension.

I2 System: The arm has medium tension (it is within the support).

I3 System: Arm with tension (it is in the arm through an inner spring).

Le système Indico a trois modèles:

Système I1: Bras sans tension.

Système I2: Bras de semitension (la tension est dans le support).

Système I3: Bras tension (la tension est dans le bras grâce au ressort interne).

Del sistema Indico sono disponibili 3 modelli:

Sistema Indico I1: Bracci senza tensione (funzionamento per caduta).

Sistema Indico I2: Bracci semi-tensione (sistema di tensione nel supporto).

Sistema Indico I3: Bracci a tensione (molla di tensione integrata nel braccio).

Motorización

Motorization

Motorisation

Motorizzazione

Salida en metros Arms projection in meters Projection en mètres Sporgenza in metri	Línea en metros / Width in meters / Ligne en mètres / Larghezza in metri				
	3,00	4,00	5,00	6,00	7,00
	Número de brazos / Number of arms / Nombre de bras / Numero di bracci				
1,00	2		2		3
1,50	LOGOS 10 / GM 12		LOGOS 15 / GM 15		LOGOS 20 / GM 20
	LOGOS 10 / GM 12		LOGOS 15 / GM 15		LOGOS 20 / GM 20

Recomendaciones / Recommendations / Recommendations / Raccomandazioni

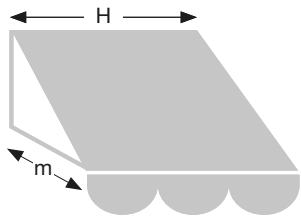

Indicol1

* NOTA: Las clases expuestas han sido obtenidas según las condiciones de ensayos descritos en los E.I.T. de Gaviota Simbac.

* NOTE: The different classes have been fulfilled according to the described conditions at Gaviota Simbac initial tests.

* NOTE: Le classement exposé a été obtenu suivant les conditions d'essais indiquées sur le manuel technique E.I.T. de Gaviota Simbac.

* NOTA: Le classi esposte, sono state ottenute secondo le condizioni di prova descritte nel manuale E.I.T. di Gaviota Simbac.

1,50	2,00	3,00	4,50	5,00	6,00	H m
3	3	3	3	3	3	1,50
3	3	3	3	3	3	1,40
3	3	3	3	3	3	1,30
3	3	3	3	3	3	1,20
3	3	3	3	3	3	1,10
3	3	3	3	3	3	1,00
3	3	3	3	3	3	0,90
3	3	3	3	3	3	0,80
3	3	3	3	3	3	0,70

- Clase 0 / Class 0 / Clase 0 / Classe 0**
No cumple homologación / It does not fulfil the requirements / Il n'est pas homologué / Non è prevista omologazione.
- Clase 1 / Class 1 / Clase 1 / Classe 1**
- Clase 2 / Class 2 / Clase 2 / Classe 2**
- Clase 3 / Class 3 / Clase 3 / Classe 3**
- IM Imposibilidad de montaje / Impossible to assemble / Impossibilité de montage / Impossibile il montaggio**

1,50	2,00	3,00	4,50	5,00	6,00	H m
3 ³	3 ³	3 ³	3 ³	3 ³	3 ³	1,50
3 ³	3 ³	3 ³	3 ³	3 ³	3 ³	1,40
3 ³	3 ³	3 ³	3 ³	3 ³	3 ³	1,30
3	3	3	3	3	3	1,20
3	3	3	3	3	3	1,10
3	3	3	3	3	3	1,00
3	3	3	3	3	3	0,90
3	3	3	3	3	3	0,80
3 ²	3 ²	3 ²	3 ²	3 ²	3 ²	0,70
3 ²	3 ²	3 ²	3 ²	3 ²	3 ²	0,60

² Sólo aplica al sistema I2

² It only applies to I2 system

² Seulement pour système I2

² Si applica al solo sistema I2

³ Sólo aplica al sistema I3

³ It only applies to I3 system

³ Seulement pour système I3

³ Si applica al solo sistema I3

Indicol2-I3 





Descripción / Description Description / Descrizione	Código / Code Code / Codice	L / m	Color / Colour Couleur / Colore
Brazo curvo I1, sin tensión. <i>Curved arm I1, without tension.</i> <i>Bras courbé I1, sans tension.</i> <i>Braccio curvo I1, senza molla.</i>	8006-2	0,70	Blanco / White / Blanc / Bianco
	8006-182	0,70	Negro / Black / Noir / Nero
	8006-227	0,70	Plata / Silver / Argent / Argento
	8006-218	0,70	Bronce / Bronze / Bronzo
	8006-147	0,70	Burdeos / Dark red / Bordeaux
	8006-146	0,70	Verde / Green / Vert
	8006-236*	0,70	Beige
Brazo curvo I1, sin tensión. <i>Curved arm I1, without tension.</i> <i>Bras courbé I1, sans tension.</i> <i>Braccio curvo I1, senza molla.</i>	8006-8	0,80	Blanco / White / Blanc / Bianco
	8006-183	0,80	Negro / Black / Noir / Nero
	8006-228	0,80	Plata / Silver / Argent / Argento
	8006-219	0,80	Bronce / Bronze / Bronzo
	8006-149	0,80	Burdeos / Dark red / Bordeaux
	8006-148	0,80	Verde / Green / Vert
	8006-237*	0,80	Beige
Brazo curvo I1, sin tensión. <i>Curved arm I1, without tension.</i> <i>Bras courbé I1, sans tension.</i> <i>Braccio curvo I1, senza molla.</i>	8006-14	0,90	Blanco / White / Blanc / Bianco
	8006-184	0,90	Negro / Black / Noir / Nero
	8006-229	0,90	Plata / Silver / Argent / Argento
	8006-220	0,90	Bronce / Bronze / Bronzo
	8006-151	0,90	Burdeos / Dark red / Bordeaux
	8006-150	0,90	Verde / Green / Vert
	8006-238*	0,90	Beige
Brazo curvo I1, sin tensión. <i>Curved arm I1, without tension.</i> <i>Bras courbé I1, sans tension.</i> <i>Braccio curvo I1, senza molla.</i>	8006-20	1,00	Blanco / White / Blanc / Bianco
	8006-185	1,00	Negro / Black / Noir / Nero
	8006-230	1,00	Plata / Silver / Argent / Argento
	8006-221	1,00	Bronce / Bronze / Bronzo
	8006-153	1,00	Burdeos / Dark red / Bordeaux
	8006-152	1,00	Verde / Green / Vert
	8006-239*	1,00	Beige





Descripción / Description Description / Descrizione	Código / Code Code / Codice	L / m	Color / Colour Couleur / Colore
Brazo curvo I1, sin tensión. <i>Curved arm I1, without tension.</i> <i>Bras courbé I1, sans tension.</i> <i>Braccio curvo I1, senza molla.</i>	8006-26	1,10	Blanco / White / Blanc / Bianco
	8006-186	1,10	Negro / Black / Noir / Nero
	8006-231	1,10	Plata / Silver / Argent / Argento
	8006-222	1,10	Bronce / Bronze / Bronzo
	8006-155	1,10	Burdeos / Dark red / Bordeaux
	8006-154	1,10	Verde / Green / Vert
	8006-240*	1,10	Beige
Brazo curvo I1, sin tensión. <i>Curved arm I1, without tension.</i> <i>Bras courbé I1, sans tension.</i> <i>Braccio curvo I1, senza molla.</i>	8006-32	1,20	Blanco / White / Blanc / Bianco
	8006-187	1,20	Negro / Black / Noir / Nero
	8006-232	1,20	Plata / Silver / Argent / Argento
	8006-223	1,20	Bronce / Bronze / Bronzo
	8006-157	1,20	Burdeos / Dark red / Bordeaux
	8006-156	1,20	Verde / Green / Vert
	8006-241*	1,20	Beige
Brazo curvo I1, sin tensión. <i>Curved arm I1, without tension.</i> <i>Bras courbé I1, sans tension.</i> <i>Braccio curvo I1, senza molla.</i>	8006-38	1,30	Blanco / White / Blanc / Bianco
	8006-492	1,30	Negro / Black / Noir / Nero
	8006-233	1,30	Plata / Silver / Argent / Argento
	8006-224	1,30	Bronce / Bronze / Bronzo
	8006-494	1,30	Burdeos / Dark red / Bordeaux
	8006-493	1,30	Verde / Green / Vert
	8006-242*	1,30	Beige
Brazo curvo I1, sin tensión. <i>Curved arm I1, without tension.</i> <i>Bras courbé I1, sans tension.</i> <i>Braccio curvo I1, senza molla.</i>	8006-44	1,40	Blanco / White / Blanc / Bianco
	8006-188	1,40	Negro / Black / Noir / Nero
	8006-234	1,40	Plata / Silver / Argent / Argento
	8006-225	1,40	Bronce / Bronze / Bronzo
	8006-159	1,40	Burdeos / Dark red / Bordeaux
	8006-158	1,40	Verde / Green / Vert
	8006-243*	1,40	Beige

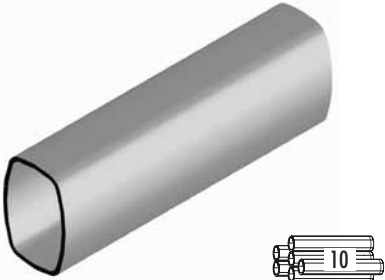

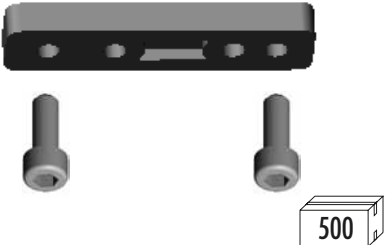
	Descripción / Description Description / Descrizione	Código / Code Code / Codice	L / m	Color / Colour Couleur / Colore
	Brazo curvo I1, sin tensión. <i>Curved arm I1, without tension.</i> <i>Bras courbé I1, sans tension.</i> <i>Braccio curvo I1, senza molla.</i>	8006-50 8006-189 8006-235 8006-226 8006-161 8006-160 8006-244*	1,50 1,50 1,50 1,50 1,50 1,50 1,50	Blanco / White / Blanc / Bianco Negro / Black / Noir / Nero Plata / Silver / Argent / Argento Bronce / Bronze / Bronzo Burdeos / Dark red / Bordeaux Verde / Green / Vert Beige
	Perfil aluminio I1, brazo curvo. <i>Aluminum profile I1, curved arm.</i> <i>Profil aluminium I1, bras courbé.</i> <i>Profilo in alluminio per braccio curvo I1.</i>	8006-569 8006-560 8006-564 8006-568 8006-566 8006-563 8006-562 8006-565*	5,8 6 6 6 6 6 6 6	Blanco / White / Blanc / Bianco Blanco / White / Blanc / Bianco Negro / Black / Noir / Nero Plata / Silver / Argent / Argento Bronce / Bronze / Bronzo Burdeos / Dark red / Bordeaux Verde / Green / Vert Beige
	Juego de codos terminal faldón I1, 2 taladros brazo curvo. <i>Set of elbow joints I1, 2 holes for curved arms.</i> <i>Jeu de coudes I1, 2 trous.</i> <i>Kit terminali lato barra prof. braccio curvo I1.</i>	8006-579 8006-581 8006-580 8006-582 8006-584 8006-583 8006-585*		Blanco / White / Blanc / Bianco Negro / Black / Noir / Nero Plata / Silver / Argent / Argento Bronce / Bronze / Bronzo Burdeos / Dark red / Bordeaux Verde / Green / Vert Beige
	Regleta zamak 4 taladros con tornillos. <i>4 bolt plate with screws.</i> <i>Réglette de fixation en zamak 4 trous avec vis.</i> <i>Kit piastrina 4 fori con viti.</i>	8013-16		Natural / Naturel



20

**Descripción / Description
Description / Descrizione**

Conjunto terminal de pared I1, brazo curvo.
Terminal wall support I1, for curved arms.
Terminale mur I1, bras courbé.
Kit terminale a parete I1 braccio curvo.

**Código / Code
Code / Codice**

8006-587
 8006-589
 8006-588
 8006-590
 8006-592
 8006-591
 8006-593*

L / m

**Color / Colour
Couleur / Colore**

Blanco / White / Blanc / Bianco
 Negro / Black / Noir / Nero
 Plata / Silver / Argent / Argento
 Bronce / Bronze / Bronzo
 Burdeos / Dark red / Bordeaux
 Verde / Green / Vert
 Beige

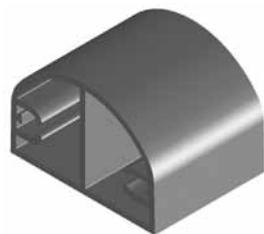

20

Separador pared para brazo curvo I1.

Adjusting support for curved arm I1.
Séparateur mur pour bras courbé I1.
Supporto di spessoramento braccio curvo I1.

8006-571
 8006-573

Blanco / White / Blanc / Bianco
 Negro / Black / Noir / Nero



Descripción / Description Description / Descrizione	Código / Code Code / Codice	L / m	Color / Colour Couleur / Colore
Juego brazo curvo I2, con semi-tensión. <i>Set of curved arms I2, with semi-tension.</i> <i>Jeu bras courbé I2, avec ressort de semi-tension.</i> <i>Kit bracci curvi I2, con molla semi-tensione.</i>	8006-512	0,60	Blanco / White / Blanc / Bianco
	8006-514	0,60	Negro / Black / Noir / Nero
	8006-513	0,60	Plata / Silver / Argent / Argento
	8006-515	0,60	Bronce / Bronze / Bronzo
	8006-518	0,60	Burdeos / Dark red / Bordeaux
	8006-517	0,60	Verde / Green / Vert
	8006-519*	0,60	Beige
Juego brazo curvo I2, con semi-tensión. <i>Set of curved arms I2, with semi-tension.</i> <i>Jeu bras courbé I2, avec ressort de semi-tension.</i> <i>Kit bracci curvi I2, con molla semi-tensione.</i>	8006-340	0,70	Blanco / White / Blanc / Bianco
	8006-342	0,70	Negro / Black / Noir / Nero
	8006-341	0,70	Plata / Silver / Argent / Argento
	8006-343	0,70	Bronce / Bronze / Bronzo
	8006-346	0,70	Burdeos / Dark red / Bordeaux
	8006-345	0,70	Verde / Green / Vert
	8006-347*	0,70	Beige
Juego brazo curvo I2, con semi-tensión. <i>Set of curved arms I2, with semi-tension.</i> <i>Jeu bras courbé I2, avec ressort de semi-tension.</i> <i>Kit bracci curvi I2, con molla semi-tensione.</i>	8006-348	0,80	Blanco / White / Blanc / Bianco
	8006-350	0,80	Negro / Black / Noir / Nero
	8006-349	0,80	Plata / Silver / Argent / Argento
	8006-351	0,80	Bronce / Bronze / Bronzo
	8006-354	0,80	Burdeos / Dark red / Bordeaux
	8006-353	0,80	Verde / Green / Vert
	8006-355*	0,80	Beige
Juego brazo curvo I2, con semi-tensión. <i>Set of curved arms I2, with semi-tension.</i> <i>Jeu bras courbé I2, avec ressort de semi-tension.</i> <i>Kit bracci curvi I2, con molla semi-tensione.</i>	8006-356	0,90	Blanco / White / Blanc / Bianco
	8006-358	0,90	Negro / Black / Noir / Nero
	8006-357	0,90	Plata / Silver / Argent / Argento
	8006-359	0,90	Bronce / Bronze / Bronzo
	8006-362	0,90	Burdeos / Dark red / Bordeaux
	8006-361	0,90	Verde / Green / Vert
	8006-363*	0,90	Beige





Descripción / Description Description / Descrizione	Código / Code Code / Codice	L / m	Color / Colour Couleur / Colore
Juego brazo curvo I2, con semi-tensión. <i>Set of curved arms I2, with semi-tension.</i> <i>Jeu bras courbé I2, avec ressort de semi-tension.</i> <i>Kit bracci curvi I2, con molla semi-tensione.</i>	8006-364	1,00	Blanco / White / Blanc / Bianco
	8006-366	1,00	Negro / Black / Noir / Nero
	8006-365	1,00	Plata / Silver / Argent / Argento
	8006-367	1,00	Bronce / Bronze / Bronzo
	8006-370	1,00	Burdeos / Dark red / Bordeaux
	8006-369	1,00	Verde / Green / Vert
	8006-371*	1,00	Beige
Juego brazo curvo I2, con semi-tensión. <i>Set of curved arms I2, with semi-tension.</i> <i>Jeu bras courbé I2, avec ressort de semi-tension.</i> <i>Kit bracci curvi I2, con molla semi-tensione.</i>	8006-372	1,10	Blanco / White / Blanc / Bianco
	8006-374	1,10	Negro / Black / Noir / Nero
	8006-373	1,10	Plata / Silver / Argent / Argento
	8006-375	1,10	Bronce / Bronze / Bronzo
	8006-378	1,10	Burdeos / Dark red / Bordeaux
	8006-377	1,10	Verde / Green / Vert
	8006-379*	1,10	Beige
Juego brazo curvo I2, con semi-tensión. <i>Set of curved arms I2, with semi-tension.</i> <i>Jeu bras courbé I2, avec ressort de semi-tension.</i> <i>Kit bracci curvi I2, con molla semi-tensione.</i>	8006-380	1,20	Blanco / White / Blanc / Bianco
	8006-382	1,20	Negro / Black / Noir / Nero
	8006-381	1,20	Plata / Silver / Argent / Argento
	8006-383	1,20	Bronce / Bronze / Bronzo
	8006-386	1,20	Burdeos / Dark red / Bordeaux
	8006-385	1,20	Verde / Green / Vert
	8006-387*	1,20	Beige



Descripción / Description Description / Descrizione	Código / Code Code / Codice	L / m	Color / Colour Couleur / Colore
Juego brazo curvo I3, con tensión. <i>Set of curved arms I3, with tension.</i> <i>Jeu bras courbé I3, avec ressort de tension.</i> <i>Kit bracci curvi I3, con molla tensione.</i>	8006-428	0,80	Blanco / White / Blanc / Bianco
	8006-430	0,80	Negro / Black / Noir / Nero
	8006-429	0,80	Plata / Silver / Argent / Argento
	8006-431	0,80	Bronce / Bronze / Bronzo
	8006-434	0,80	Burdeos / Dark red / Bordeaux
	8006-433	0,80	Verde / Green / Vert
	8006-435*	0,80	Beige
Juego brazo curvo I3, con tensión. <i>Set of curved arms I3, with tension.</i> <i>Jeu bras courbé I3, avec ressort de tension.</i> <i>Kit bracci curvi I3, con molla tensione.</i>	8006-436	0,90	Blanco / White / Blanc / Bianco
	8006-438	0,90	Negro / Black / Noir / Nero
	8006-437	0,90	Plata / Silver / Argent / Argento
	8006-439	0,90	Bronce / Bronze / Bronzo
	8006-442	0,90	Burdeos / Dark red / Bordeaux
	8006-441	0,90	Verde / Green / Vert
	8006-443*	0,90	Beige
Juego brazo curvo I3, con tensión. <i>Set of curved arms I3, with tension.</i> <i>Jeu bras courbé I3, avec ressort de tension.</i> <i>Kit bracci curvi I3, con molla tensione.</i>	8006-444	1,00	Blanco / White / Blanc / Bianco
	8006-446	1,00	Negro / Black / Noir / Nero
	8006-445	1,00	Plata / Silver / Argent / Argento
	8006-447	1,00	Bronce / Bronze / Bronzo
	8006-450	1,00	Burdeos / Dark red / Bordeaux
	8006-449	1,00	Verde / Green / Vert
	8006-451*	1,00	Beige
Juego brazo curvo I3, con tensión. <i>Set of curved arms I3, with tension.</i> <i>Jeu bras courbé I3, avec ressort de tension.</i> <i>Kit bracci curvi I3, con molla tensione.</i>	8006-452	1,10	Blanco / White / Blanc / Bianco
	8006-454	1,10	Negro / Black / Noir / Nero
	8006-453	1,10	Plata / Silver / Argent / Argento
	8006-455	1,10	Bronce / Bronze / Bronzo
	8006-458	1,10	Burdeos / Dark red / Bordeaux
	8006-457	1,10	Verde / Green / Vert
	8006-459*	1,10	Beige







Descripción / Description Description / Descrizione	Código / Code Code / Codice	L / m	Color / Colour Couleur / Colore
Juego brazo curvo I3, con tensión. <i>Set of curved arms I3, with tension.</i> <i>Jeu bras courbé I3, avec ressort de tension.</i> <i>Kit bracci curvi I3, con molla tensione.</i>	8006-460	1,20	Blanco / White / Blanc / Bianco
	8006-462	1,20	Negro / Black / Noir / Nero
	8006-461	1,20	Plata / Silver / Argent / Argento
	8006-463	1,20	Bronce / Bronze / Bronzo
	8006-466	1,20	Burdeos / Dark red / Bordeaux
	8006-465	1,20	Verde / Green / Vert
	8006-467*	1,20	Beige
Juego brazo curvo I3, con tensión. <i>Set of curved arms I3, with tension.</i> <i>Jeu bras courbé I3, avec ressort de tension.</i> <i>Kit bracci curvi I3, con molla tensione.</i>	8006-468	1,30	Blanco / White / Blanc / Bianco
	8006-470	1,30	Negro / Black / Noir / Nero
	8006-469	1,30	Plata / Silver / Argent / Argento
	8006-471	1,30	Bronce / Bronze / Bronzo
	8006-474	1,30	Burdeos / Dark red / Bordeaux
	8006-473	1,30	Verde / Green / Vert
	8006-475*	1,30	Beige
Juego brazo curvo I3, con tensión. <i>Set of curved arms I3, with tension.</i> <i>Jeu bras courbé I3, avec ressort de tension.</i> <i>Kit bracci curvi I3, con molla tensione.</i>	8006-476	1,40	Blanco / White / Blanc / Bianco
	8006-478	1,40	Negro / Black / Noir / Nero
	8006-477	1,40	Plata / Silver / Argent / Argento
	8006-479	1,40	Bronce / Bronze / Bronzo
	8006-482	1,40	Burdeos / Dark red / Bordeaux
	8006-481	1,40	Verde / Green / Vert
	8006-483*	1,40	Beige
Juego brazo curvo I3, con tensión. <i>Set of curved arms I3, with tension.</i> <i>Jeu bras courbé I3, avec ressort de tension.</i> <i>Kit bracci curvi I3, con molla tensione.</i>	8006-484	1,50	Blanco / White / Blanc / Bianco
	8006-486	1,50	Negro / Black / Noir / Nero
	8006-485	1,50	Plata / Silver / Argent / Argento
	8006-487	1,50	Bronce / Bronze / Bronzo
	8006-490	1,50	Burdeos / Dark red / Bordeaux
	8006-489	1,50	Verde / Green / Vert
	8006-491*	1,50	Beige



Indicol2 - Indicol3

	Descripción / Description Description / Descrizione	Código / Code Code / Codice	L / m	Color / Colour Couleur / Colore		
 	<p>Perfil aluminio Indicol2 - Indicol3.</p> <p><i>Aluminum profile Indicol2 - Indicol3.</i></p> <p><i>Profil aluminium Indicol2 - Indicol3.</i></p> <p><i>Profilo alluminio braccio curvo Indico I2 - Indico I3.</i></p>	<p>8006-505</p> <p>8006-412</p> <p>8006-414</p> <p>8006-413</p> <p>8006-415</p> <p>8006-418</p> <p>8006-417</p> <p>8006-419*</p>	<p>5,8</p> <p>6</p> <p>6</p> <p>6</p> <p>6</p> <p>6</p> <p>6</p> <p>6</p>	<p>Blanco / White / Blanc / Bianco</p> <p>Blanco / White / Blanc / Bianco</p> <p>Negro / Black / Noir / Nero</p> <p>Plata / Silver / Argent / Argento</p> <p>Bronce / Bronze / Bronzo</p> <p>Burdeos / Dark red / Bordeaux</p> <p>Verde / Green / Vert</p> <p>Beige</p>		
	 	<p>Juego codos Indicol2 - Indicol3, inyección.</p> <p><i>Injection elbow joints Indicol2 - Indicol3.</i></p> <p><i>Jeu de coudes Indicol2 - Indicol3, injection.</i></p> <p><i>Kit terminali per braccio curvo Indico I2 - Indico I3.</i></p>	<p>8006-404</p> <p>8006-406</p> <p>8006-405</p> <p>8006-407</p> <p>8006-410</p> <p>8006-409</p> <p>8006-411*</p>		<p>Blanco / White / Blanc / Bianco</p> <p>Negro / Black / Noir / Nero</p> <p>Plata / Silver / Argent / Argento</p> <p>Bronce / Bronze / Bronzo</p> <p>Burdeos / Dark red / Bordeaux</p> <p>Verde / Green / Vert</p> <p>Beige</p>	
		 	<p>Juego de soporte Indicol2, con semi-tensión.</p> <p><i>Set of wall supports Indicol2, with semi-tension.</i></p> <p><i>Jeu support Indicol2, avec ressort de semi-tension.</i></p> <p><i>Kit supporti Indico I2, molla semi-tensione.</i></p>	<p>8006-388</p> <p>8006-390</p> <p>8006-389</p> <p>8006-391</p> <p>8006-394</p> <p>8006-393</p> <p>8006-395*</p>		<p>Blanco / White / Blanc / Bianco</p> <p>Negro / Black / Noir / Nero</p> <p>Plata / Silver / Argent / Argento</p> <p>Bronce / Bronze / Bronzo</p> <p>Burdeos / Dark red / Bordeaux</p> <p>Verde / Green / Vert</p> <p>Beige</p>

Indicol2 - Indico I3

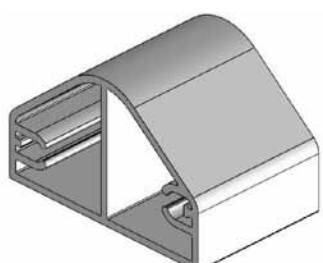
		Descripción / Description Description / Descrizione	Código / Code Code / Codice	L / m	Color / Colour Couleur / Colore
	Juego de soporte Indicol3, con tensión. <i>Set of brackets Indicol3, with tension.</i> <i>Platines de bras Indicol3, avec ressort.</i> <i>Kit supporti Indico I3, con molla tensione.</i>		8006-529	0,70	Blanco / White / Blanc / Bianco
			8006-531	0,70	Negro / Black / Noir / Nero
			8006-530	0,70	Plata / Silver / Argent / Argento
			8006-532	0,70	Bronce / Bronze / Bronzo
			8006-534	0,70	Burdeos / Dark red / Bordeaux
			8006-533	0,70	Verde / Green / Vert
			8006-535*	0,70	Beige
		Juego de soporte Indicol3, con tensión.		0,80 m	8006-420
		0,90 m	8006-422	Negro / Black / Noir / Nero	
<i>Set of brackets Indicol3, with tension.</i>		1,00 m	8006-421	Plata / Silver / Argent / Argento	
<i>Platines de bras Indicol3, avec ressort.</i>		1,10 m	8006-423	Bronce / Bronze / Bronzo	
<i>Kit supporti Indico I3, con molla tensione.</i>		1,20 m	8006-426	Burdeos / Dark red / Bordeaux	
		1,30 m	8006-425	Verde / Green / Vert	
		1,40 m	8006-427*	Beige	
		1,50 m			
	Separador pared para brazo curvo I2-I3. <i>Adjusting support for curved arm I2-I3.</i> <i>Séparateur mur pour bras courbé I2-I3.</i> <i>Supporto di spessoramento braccio curvo I2-I3.</i>		8006-600		Blanco / White / Blanc / Bianco
			8006-602		Negro / Black / Noir / Nero
